

Single-phase Portable Pumps

LB/HS/NK/LSC/LSP/FAMILY





SINGLE-PHASE PORTABLE DEWATERING PUMPS

Tsurumi single-phase portable dewatering pumps are compact and lightweight, so they are very easy handle and carry. Available in an extensive lineup of motor outputs ranging from 0.1 to 2.2kW, these pumps are suited for a wide range of applications besides general pumping and drainage, including slurries, residues and household uses.

Though compact in size, these pumps pack a host of proprietary technologies that Tsurumi has tested and proven over many years, including the anti-wicking cable, inside mechanical seal with silicon carbide face and Oil Lifter*, etc. Additionally, key components that are prone to wear are made of durable materials and pumps as a whole are designed for continuous duty. For these reasons, Tsurumi single-phase portable pumps are a popular choice at civil engineering, construction and other work sites that demand high reliability.

* excluding FAMILY-series

Tsurumi has been manufacturing construction dewatering pumps for more than 50 years. This has led to numerous technologies and know-how for improving the durability and maintainability of pumps in the rental and construction markets where rugged work environments demand heavy-duty specifications. All of Tsurumi's pumps are designed and built to be durable and reliable so as to serve users dependably.

LB

-Typical Pumps-



LSC

-Residue Drainage Pump-



HS

-Multi-field Use Pumps-



LSP

-Free-positioning Residue Drainage Pump-



NK

-Larger Output Pumps-



FAMILY

-Domestic Pumps-



Structure



LB



HS



LSC

1 Anti-Wicking Cable Entry

Prevents water incursion due to capillary action should the cable sheath be damaged or the end of cable submerged. Also prevents moist air from infiltrating the motor housing and condensation from forming inside the housing due to temperature differences between the housing and outside air.

2 Motor Protector

MTP (0.48kW and below)

Detects excess heat, therefore, protecting the pump against overheating and dry-running.

CTP (0.55kW and above)

Directly cuts the motor circuit if excessive heat builds up or overcurrent occurs in the motor.

3 Dual Inside Mechanical Seals with Silicon Carbide Face

Inside Mechanical Seal with Silicon Carbide Face (FAMILY)

Isolated in the oil chamber where a clean, non-corrosive and abrasion-free lubricating environment is maintained. Compared with the water-cooled outside mechanical seal, it reduces the risk of failure caused by dry-heating and adhering matter. The silicon carbide provides 5 times higher corrosion, wear and heat resistance than the tungsten carbide.

4 Oil Lifter [Patented]

* Not available for FAMILY

Provides lubrication and cooling of the seal faces down to 1/3 of normal oil level, thus maintaining a stable shaft sealing effect and prolonging seal life longer.

5 V-Ring / Oil Seal (excluding HS(Z/R)2.4S, FAMILY)

Used as a "Dust Seal", they protect the mechanical seal from abrasive particles.

6 Cable Clip (excluding NK3-22L, LSP, FAMILY)

Prevents unexpected water incursion that can occur if the cable is damaged, by protecting the cable against the tugging and rough handling found at construction sites.

7 Agitator

For HS and HSZ

Prevents the air lock that tends to take place on vortex or semi-vortex pumps.

For HSD

Assists the pump in sucking and transferring bentonite slurry, slime, mud, and water with high sand content.

8 Resin-made Stand (HS / HSZ / HSD)

Rubber Stand (HSR / LSC / LSP)

Prevents scratching of floor surface.

9 Multi-Directional Hose Coupling (LB / LB-A / HSR / LSC)

Can be configured for inclined or vertical discharge, allowing for smoother installation.

Feature

Selection Table

		Submersible						Non Submersible	Submersible
		Drainage		Slurry	Residue	Drainage	Residue		Domestic
		LB	HS	HSD	HSR	NK	LSC	LSP	FAMILY
Discharge Bore	mm	50(80)	50 · 80	50	50	50 · 80	25	25	15, 25
Motor Output	kW	0.48 - 1.5	0.4 · 0.75	0.55	0.4	1.5 · 2.2	0.48	0.48	0.1
Discharge Design	Top Discharge	Flow-Thru	●				●	●	●
		Side Flow				●			
	Side Discharge		●	●	●				
Automatic Operation		LB-A (Electrodes)	HSZ (Float)	—	—	—	—	—	FAMILY-A (Cylindrical Float)
Page No.		7 - 8	9 - 10		11 - 12	13 - 14	15 - 16	17 - 18	

Motor Cooling & Discharge Design

Top Discharge, Flow-Thru Design

This design provides maximum motor cooling efficiency allowing continuous operation at low water levels and extended dry-run capability, and also allows the shape of the pump to be cylindrical and slim for installation in a well casing for deep well dewatering.

LB LB-A LSC LSP FAMILY FAMILY-A

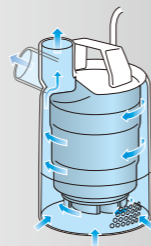

Top Discharge, Side Flow Design

This design assures efficient motor cooling even if the pump runs with its motor exposed to air, and also allows the overall diameter of the pump to be reduced for installation in confined spaces.

NK

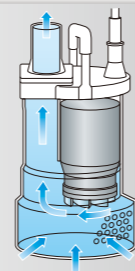

Side Discharge, Spiral Design

The pump has a spiral pump casing that facilitates smoother passage of foreign objects like mud and soil contained in the pumped liquid. It is a simple and practical design that facilitates inspection and repair work.

HS HSZ HSD HSR

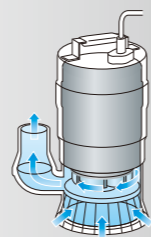

Automatic Operation

The automatic model only operates when sufficient water is present. It not only reduces power consumption but also extends the life of wear parts of the pump as it eliminates dry-running that causes early wear-out.

Electrodes (LB-A)

Tsurumi has developed a unique automatic control device utilizing electrodes. The pump stops automatically in about one minute after the water surface falls below the electric probe.

Since this mechanism eliminates dry-running, the pump can reduce power consumption by up to 40 percent compared with non-automatic pumps (Tsurumi comparison). It also prevents chattering caused by a turbulent water surface and extends operating life.



Float Switch (HSZ / FAMILY-A)

This automatic operation system is controlled by a float switch. When the water level rises and raises the float switch to a preset level, the switch turns on, and the pump starts. When the water level lowers to the preset level, pump operation stops.

Residue Drainage

HSR Can pump water as shallow as 5mm from the bottom of the pump and drain water to 1mm in depth.



LSC Can drain water to 1mm in depth. A valve seat and swing check valve prevent suctioned water from backflowing.



LSP Can pump pooled water from shallow recesses using the suction attachment. A new syphon breaker mechanism prevents backflowing and the seal water from draining out.



FAMILY option Attaching the optional residue adapter to the pump casing allows draining to 1mm in depth.



LB -Typical Pumps-

The LB/LB-A series are submersible single-phase portable drainage pumps. The discharge direction is selectable between vertical and inclined, which prevents folding or bending of the discharge hose.* Every LB-series is slim design enough to be accommodated in an 8-inch pipe. The LB-A series with an innovative electrode type relay unit automatically starts and stops the pump to eliminate dry-running. This mechanism greatly reduces power consumption and extends operating life.

* excluding LB-1500



- Flow-thru Design
 - Anti-wicking Cable Entry
 - Motor Protector
 - Dual Inside Mechanical Seal
 - Oil Lifter [Patented]
 - V-ring
 - Cable Clip
 - Multi-directional Hose Coupling*
- * excluding LB-1500

Model	Discharge Bore mm	Motor Output kW	Phase	Starting Method	Solids Passage mm	Dry Weight kg	Cable Length m
LB	LB-480	50	Single	Capacitor Run	6	10.4	5
	LB-800	50(80)		Capacitor Run	6	13.1	5
	LB-1500	50(80)		Capacitor Start	6	33	10
LB-A -Automatic-	LB-480A	50	Single	Capacitor Run	6	11	5
	LB-800A	50(80)		Capacitor Run	6	13.7	5

- Male threaded coupling for pipe connection available on special request
- 80mm discharge bore available on special request
- Weights excluding cable

Performance Curves

Standard and Automatic models have the identical performance.

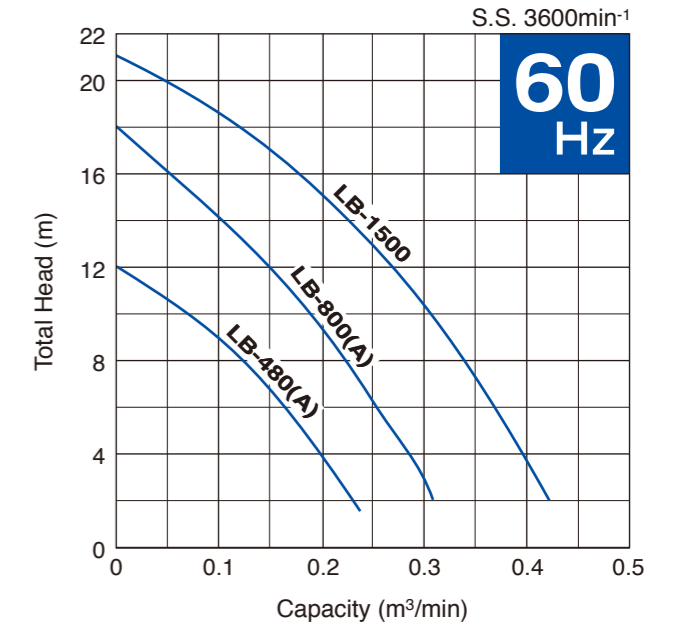
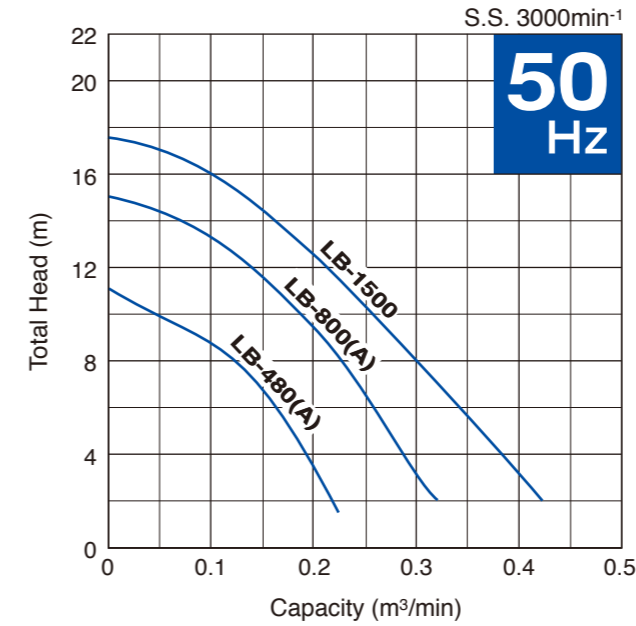

Dimensions

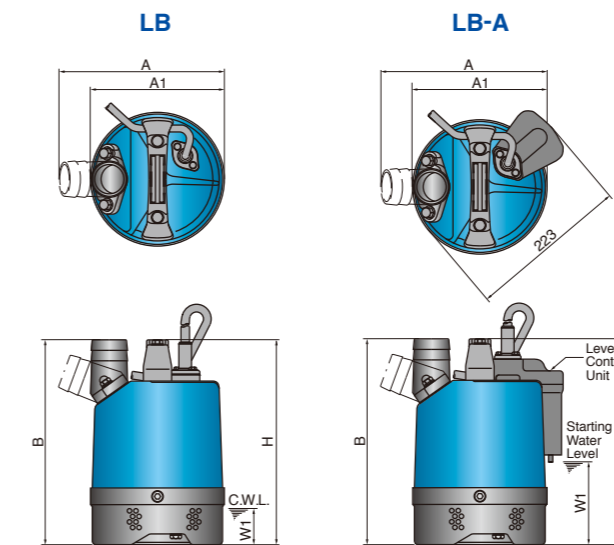

Unit: mm

Model	A	A1	B	H	W1
LB-480	233	189	-	286	50
LB-800	230	186	338	341	50
LB-1500	187	-	600	593	80
LB-480A	233	189	-	286	115
LB-800A	230	186	338	341	170

Automatic Operation (LB-A)

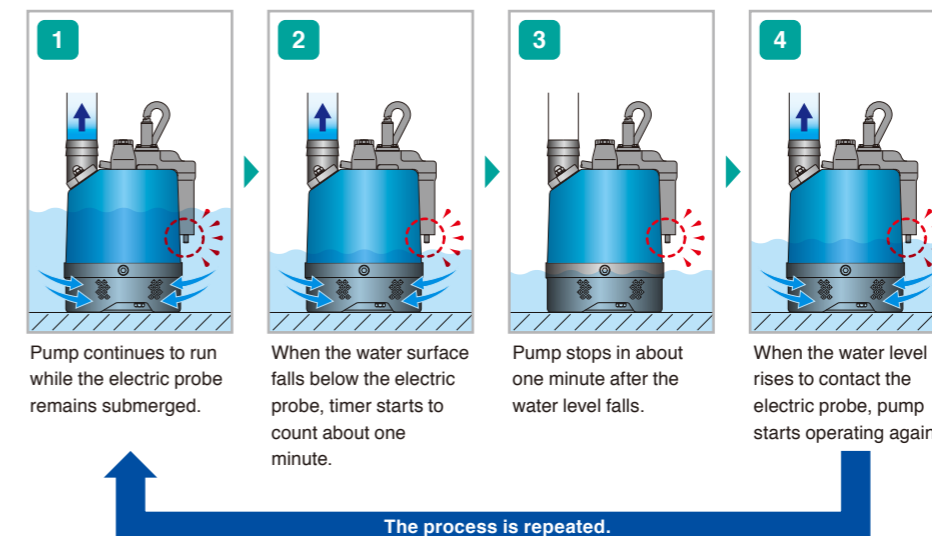

Optional Accessory

Extension Probe x 2

It is possible to set a lower starting water level by using an extension probe (optional accessory). The starting water level is adjustable because the extension probe can be cut to the desired length as it is made of coil spring.

HS - Multi-field Use Pumps-

The HS/HSZ/HSD/HSR series are submersible single-phase portable pumps. The shaft-mounted agitator prevents the air lock that tends to take place on vortex or semi-vortex pumps.* The rubber/resin-made stand protects the floor surface from scratching. The HSZ-series with a single float switch reduces power consumption and extends operating life.

The HSD pump is equipped with a high-chromium cast iron agitator that assists smooth suction of the settled matters. The HSR pump can start pumping if there is water with its level of 5mm or more and can continue pumping the water level goes down to 1mm. Additionally, the discharge direction is selectable between vertical and inclined, which prevents folding or bending of the discharge hose.

* excluding HSR



- Spiral Design
- Anti-wicking Cable Entry
- Motor Protector
- Dual Inside Mechanical Seal
- Oil Lifter [Patented]
- V-ring (0.55kW and above)
- Cable Clip
- Rubber / Resin-made Stand
- Agitator (HS/HSZ/HSD)
- Multi-directional Hose Coupling (HSR)

Model	Discharge Bore mm	Motor Output kW	Phase	Starting Method	Solids Passage mm	Dry Weight kg	Cable Length m
HS	HS2.4S	50	Single	Capacitor Run	7	11.3	5
	HS2.75S	50		Capacitor Run	7	16.4	5
	HS3.75S	80		Capacitor Run	7	16.8	5
HSZ -Automatic-	HSZ2.4S	50		Capacitor Run	7	11.3	5
	HSZ2.75S	50		Capacitor Run	7	16.4	5
	HSZ3.75S	80		Capacitor Run	7	16.8	5
HSD -Slurry-	HSD2.55S	50		Capacitor Run	9	14	5
HSR -Residue-	HSR2.4S	50		Capacitor Run	3	10.8	5

• Male threaded coupling for pipe connection available on special request
• Weights excluding cable

Performance Curves

Standard and Automatic models have the identical performance.

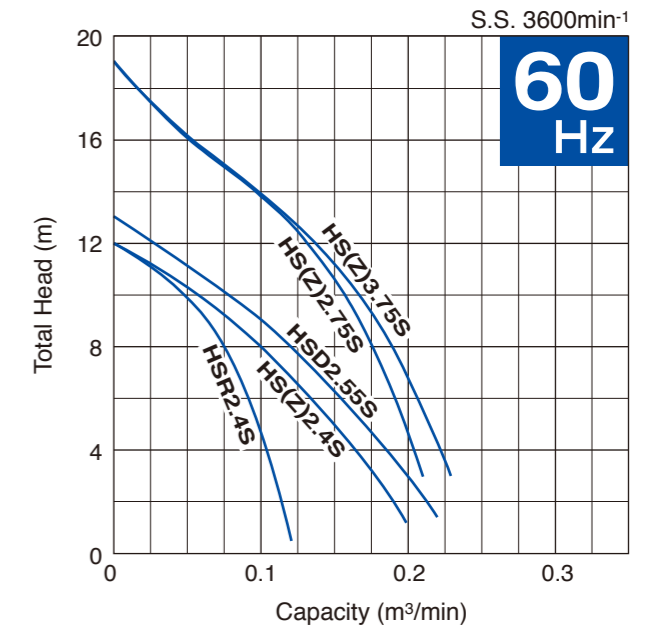
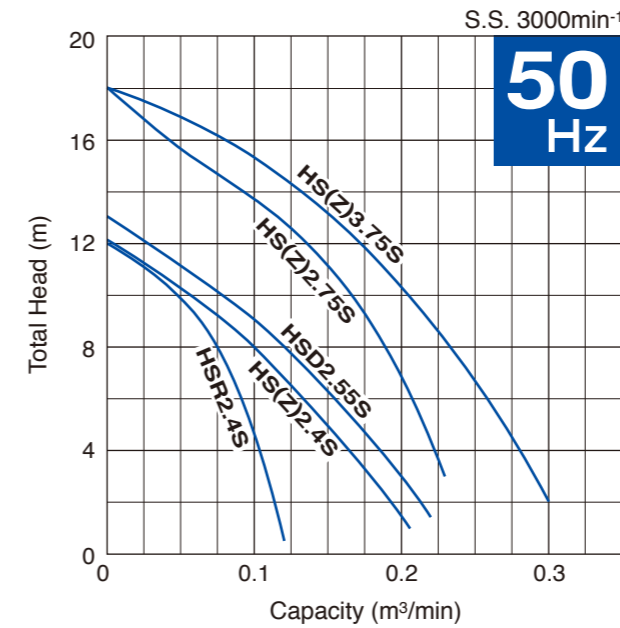

Dimensions

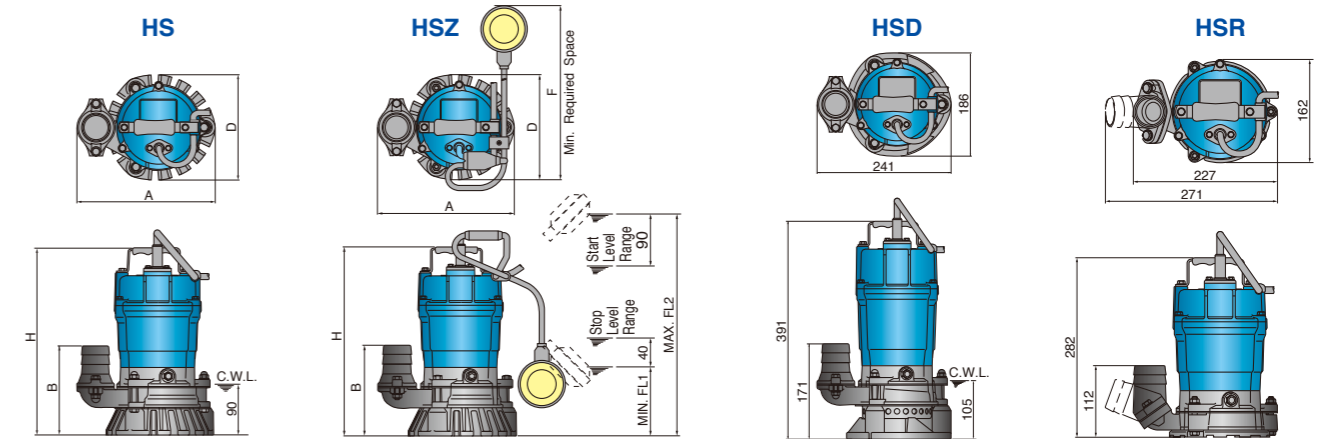

Unit: mm

Model	A	B	D	H	F	FL1	FL2
HS2.4S	241	158	184	328	-	-	-
HS2.75S/HS3.75S	285	218	184	394	-	-	-
HSZ2.4S	241	158	184	328	340	120	385
HSZ2.75S/HSZ3.75S	285	218	184	394	370	150	475

Automatic Operation (HSZ)

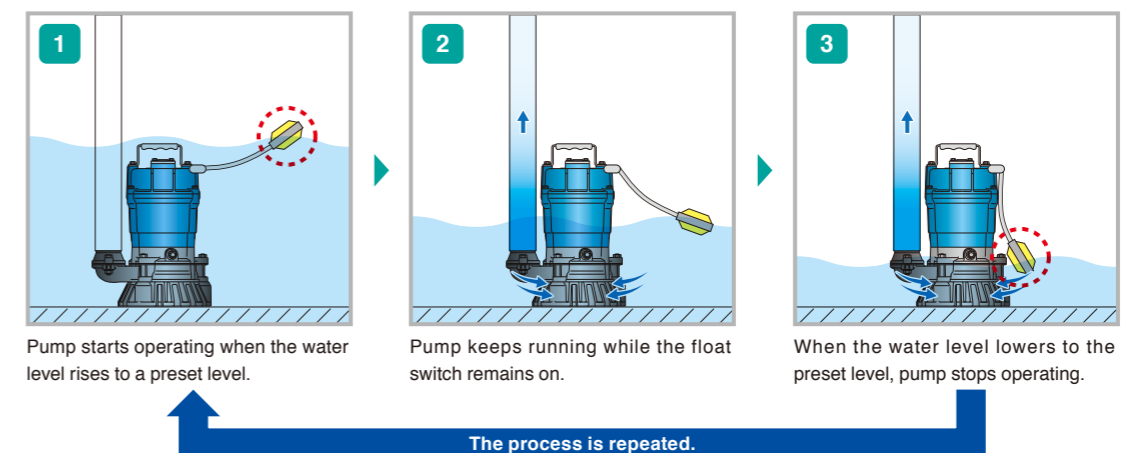

NK –Larger Output Pumps–

The NK-series is a submersible single-phase portable drainage pump having a larger output motor. Though it is a single-phase unit, the pump has the durability equivalent to three-phase drainage pumps, since the wear parts are made of abrasion-resistant materials. The slim design allows the pump to be placed in a confined space.

NK3-15



- Side Flow Design
- Anti-wicking Cable Entry
- Motor Protector
- Dual Inside Mechanical Seal
- Oil Lifter [Patented]
- V-ring / Oil Seal
- Cable Clip*
* excluding NK3-22L

Model	Discharge Bore mm	Motor Output kW	Phase	Starting Method	Solids Passage mm	Dry Weight kg	Cable Length m
NK3-15	50	1.5	Single	Capacitor Start	8.5	29	10
NK4-22	50	2.2		Capacitor Start + Capacitor Run	8.5	29	10
NK3-22L	80	2.2		Capacitor Start + Capacitor Run	8.5	40	10

• Male threaded coupling for pipe connection available on special request
• Weights excluding cable

Performance Curves

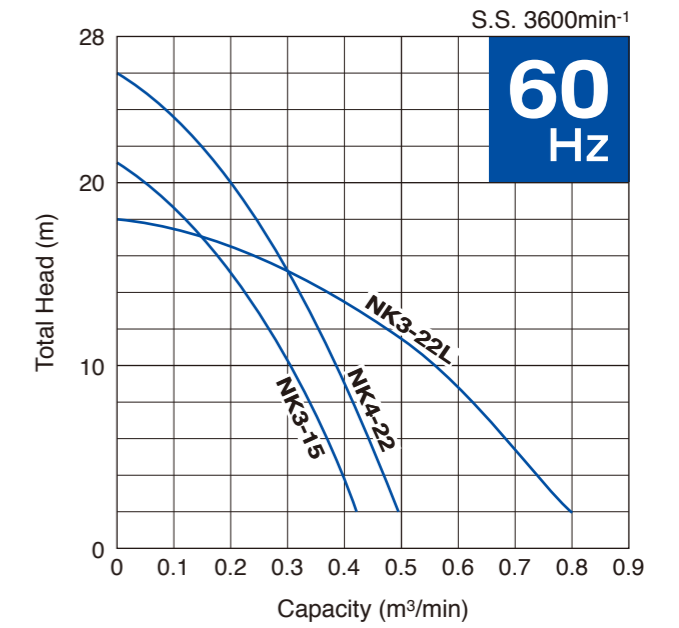
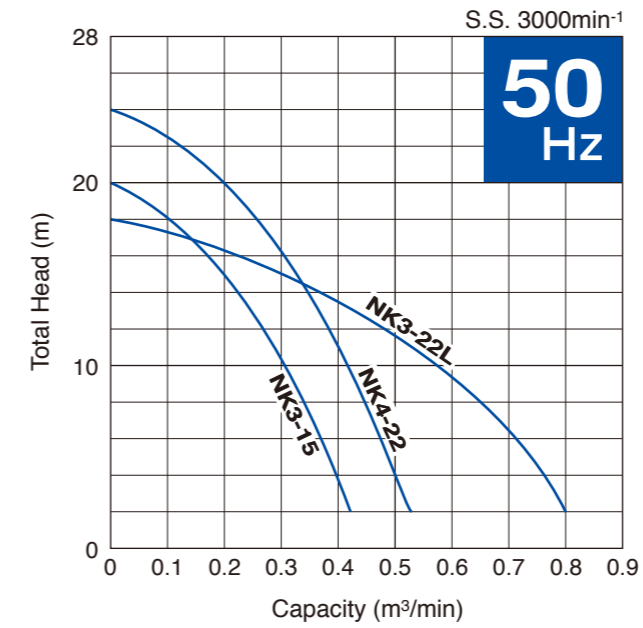

Dimensions

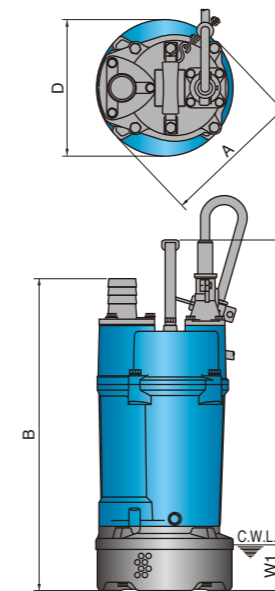

Unit: mm

Model	A	B	D	H	W1
NK3-15	243	546	240	614	80
NK4-22	243	546	240	614	80
NK3-22L	236	601	216	669	120

LSC –Residue Drainage Pump–

The LSC pump is a submersible single-phase portable residue drainage pump. The specially designed bottom plate enables the pump to drain down to 1mm water level. It has a swing check valve that prevents reverse-flow of the sucked water when the pump stops its operation. The rubber stand protects the floor surface from scratching. The discharge direction is selectable between vertical and inclined, which prevents folding or bending of the discharge hose.

LSC1.4S



- Flow-thru Design
- Anti-wicking Cable Entry
- Motor Protector
- Dual Inside Mechanical Seal
- Oil Lifter [Patented]
- V-ring
- Cable Clip
- Rubber Stand
- Reverse-flow Prevention Mechanism
- Multi-directional Hose Coupling

LSP –Free-positioning Residue Drainage Pump–

The LSP pump is a single-phase portable self-priming residue drainage pump incorporating a submersible motor. The suction attachment, supplied as standard, makes the pump drain water down to floor level. The pump is equipped with a siphon breaker mechanism that prevents reverse-flow when the pump stops its operation. It is lightweight and easy to carry, as the major components are made of aluminum alloy and synthetic rubber. Since it incorporates a submersible motor, there is absolutely no problem even it is submerged in water.

LSP1.4S



- Flow-thru Design
- Anti-wicking Cable Entry
- Motor Protector
- Dual Inside Mechanical Seal
- Oil Lifter [Patented]
- V-ring
- Rubber Stand
- Free-positioning Suction Attachment
- Reverse-flow Prevention Mechanism

Model	Discharge Bore	Motor Output	Phase	Starting Method	Dry Weight	Cable Length
	mm	kW			kg	m
LSC1.4S	25	0.48	Single	Capacitor Run	12	5

- Male threaded coupling for pipe connection available on special request
- Weights excluding cable

Dimensions

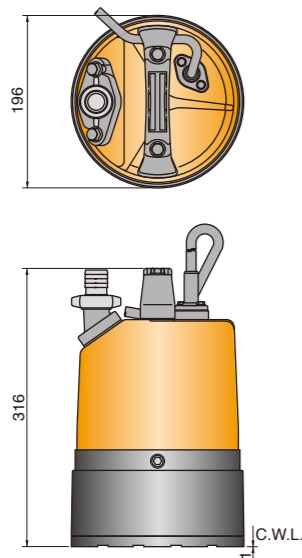

Performance Curves

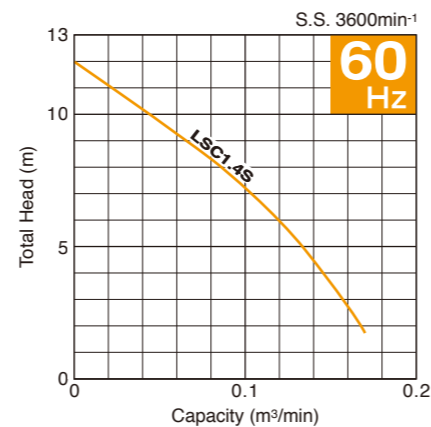
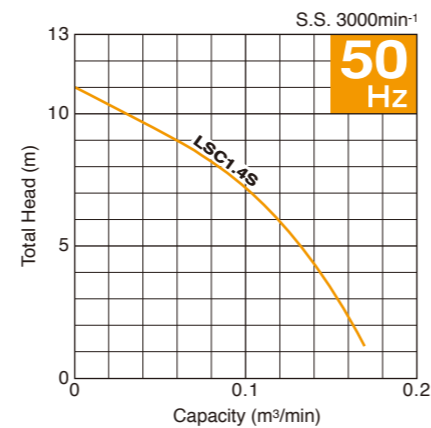

Model	Suction x Discharge Bore	Motor Output	Phase	Starting Method	Max. Head 50/60Hz	Max. Capacity 50/60Hz	Max. Vacuum	Dry Weight	Cable Length
	mm	kW			m	L/min	kPa(mmHg)	kg	m
LSP1.4S	25 x 25	0.48	Single	Capacitor Run	6.9 / 7.8	50 / 55	-73.3 (-550)	16.5	5

- Weights excluding cable

Dimensions

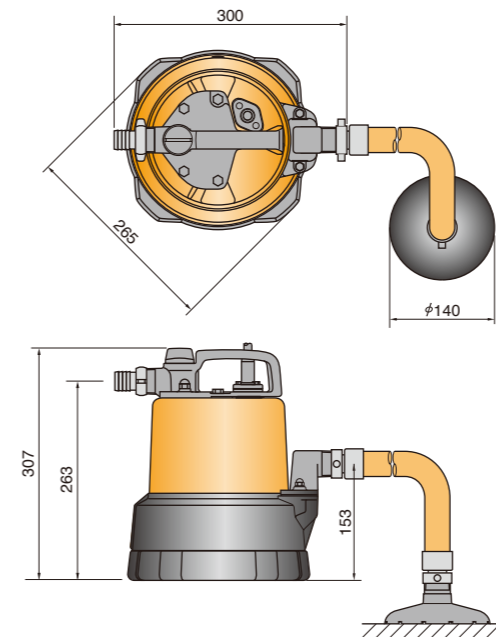

FAMILY – Domestic Pumps –

The FAMILY/FAMILY-A series are submersible single-phase portable drainage pumps. In addition to the 25mm hose coupling, it also comes with an easy-to-attach 15mm hose coupling as a standard accessory. The FAMILY-A pump with a cylindrical float switch reduces power consumption and extends operating life. Moreover, it can be used as a residue pump and drain water to 1mm in depth by attaching the optional residue adapter to the pump casing.



- Flow-thru Design
 - Anti-wicking Cable Entry
 - Motor Protector
 - Inside Mechanical Seal
- Option
- Residue Adapter
 - Seawater-Resistant Coating

Model	Discharge Bore mm	Motor Output kW	Phase	Starting Method	Dry Weight kg	Cable Length m
FAMILY-12	15, 25	0.1	Single	Capacitor Run	3.4	3
FAMILY-12A -Automatic-	15, 25	0.1		Capacitor Run	3.6	3

• Weights excluding cable

Dimensions

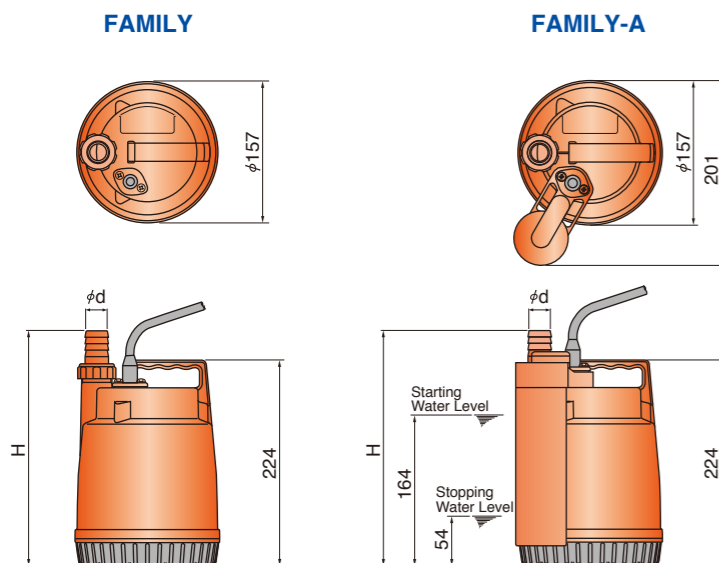

Unit: mm

φd	H
15	250
25	256

Performance Curves

Standard and Automatic models have the identical performance.

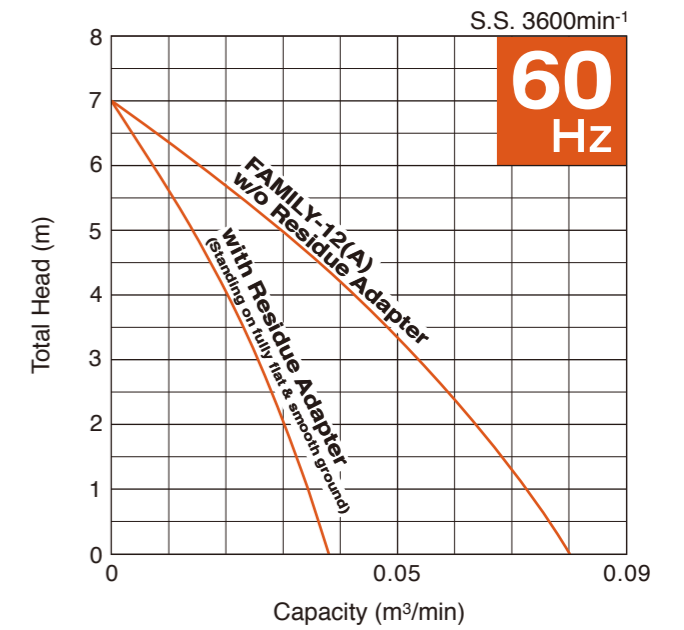
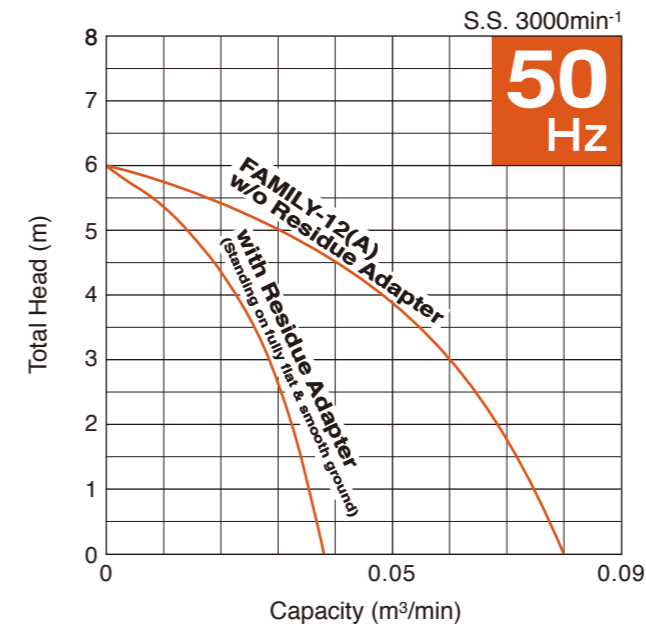

Automatic Operation (FAMILY-A)

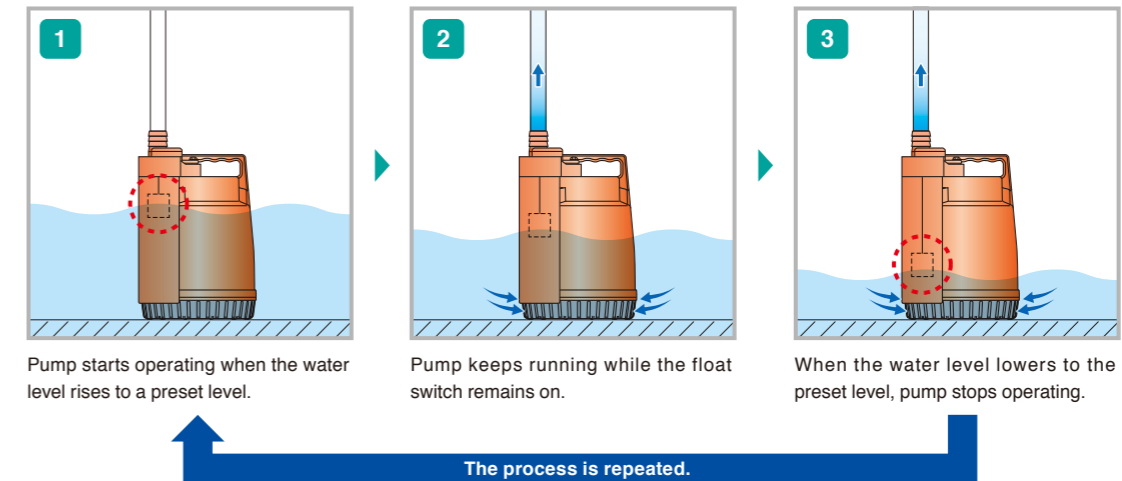

Optional Accessory

Residue Adapter (FAMILY)

Attaching the optional residue adapter to the pump casing allows draining to 1mm in depth.

As standard specification, residual water by **12mm** can be drained.

With residue adapter, residual water by **1mm** can be drained.

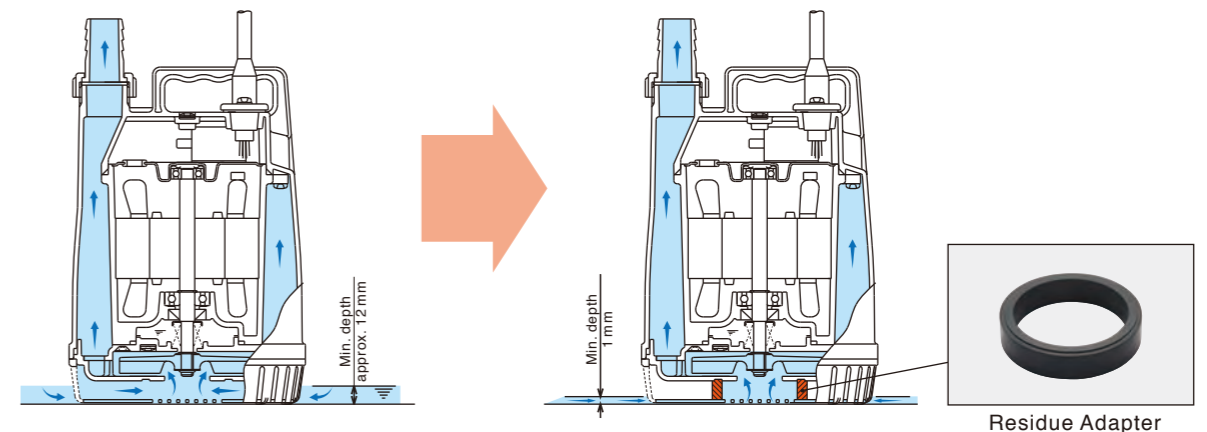

Specifications

		LB			LB-A -Automatic-		HS		HSZ -Automatic-			HSD -Slurry-	HSR -Residue-	NK			LSC -Residue-	LSP -Residue-	FAMILY	FAMILY-A -Automatic-	
		LB-480	LB-800	LB-1500	LB-480A	LB-800A	HS2.4S	HS2.75S HS3.75S	HSZ2.4S	HSZ2.75S HSZ3.75S		HSD2.55S	HSR2.4S	NK3-15	NK4-22	NK3-22L	LSC1.4S	LSP1.4S	FAMILY-12	FAMILY-12A	
PUMP	Discharge Bore mm	50	50(80)		50	50(80)	50	50 80	50	50 80		50			80	25		15, 25			
	Discharge Connection	Hose Coupling										Hose Coupling									
	Solids Passage mm	6					7					9	3	8.5			—				
	Impeller	Semi-vortex		Semi-open		Semi-vortex					Semi-vortex					Semi-open		Semi-vortex			
		Urethane Rubber		High-chromium Cast Iron		Urethane Rubber					High-chromium Cast Iron		Urethane Rubber		Ductile Cast Iron		High-chromium Cast Iron		Urethane Rubber		Glass-fiber Reinforced Resin
	V-Ring / Oil Seal	Nitrile Butadiene Rubber					—	Nitrile Butadiene Rubber	—	Nitrile Butadiene Rubber	Nitrile Butadiene Rubber					—					
	Casing	Synthetic Rubber					Gray Cast Iron	Ductile Cast Iron	Gray Cast Iron	Ductile Cast Iron	Ductile Cast Iron			Synthetic Rubber		Gray Cast Iron	Synthetic Rubber		Resin		
	Shaft Seal	Dual Inside Mechanical Seals (with Oil Lifter)										Dual Inside Mechanical Seals (with Oil Lifter)								Inside Mechanical Seal	
Silicon Carbide										Silicon Carbide											
Agitator	—					Sintered Alloy					High-chromium Cast Iron					—					
MOTOR	Type	Continuous-duty Rated, Dry-type Induction Motor										Continuous-duty Rated, Dry-type Induction Motor									
	Output kW	0.48	0.75	1.5	0.48	0.75	0.4	0.75	0.4	0.75		0.55	0.4	1.5	2.2		0.48		0.1		
	Phase	Single-phase										Single-phase									
	Pole	2										2									
	Insulation	E		B		E					E			F		B		E			
	Starting Method	Capacitor Run		Capacitor Start		Capacitor Run					Capacitor Run			Capacitor Start		Capacitor Start + Capacitor Run		Capacitor Run			
	Motor Protector (built-in)	MTP	CTP		MTP	CTP	MTP	CTP	MTP	CTP		CTP	MTP	CTP			MTP				
	Lubricant	ml		155		350		155		160			160			270		155	150	30	
		Turbine Oil (ISO VG32)										Turbine Oil (ISO VG32)								Liquid Paraffin (ISO VG15)	
	Shaft	403 Stainless Steel										403 Stainless Steel					420 Stainless Steel		403 Stainless Steel		420 Stainless Steel
Cable	m		5		10		5					5			10		5		3		
	PVC		Chloroprene Rubber		PVC					PVC			Chloroprene Rubber		PVC						
Automatic Control Device	—				Electrodes		—		Float Switch		—								Cylindrical Float Switch		
Dry Weight* kg	10.4	13.1	33	11	13.7	11.3	16.4 16.8	11.3	16.4 16.8		14	10.8	29		40	12	16.5	3.4	3.6		

* Weights excluding cable



We reserve the right to change the specifications and designs for improvement without prior notice.

**TSURUMI
MANUFACTURING CO., LTD.**

Your Dealer